

THURNE IBS 1000 Bacon Slicer

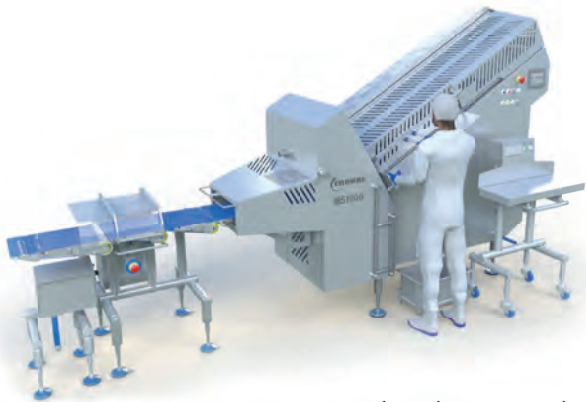

IBS 1000 with Predictive Upgrade

Key Performance

- Fast reload of <6 seconds
- High blade speed up to 1500 rpm
- Gripper fed for high yields
- Minimum butt ends (80-100g typical)
- Yield improvement of 1.5 to 2% vs. traditional flatbed slicers

High quality retail and food service bacon slicing for manual packing operations

- High speed bacon blade for consistent slice thickness and integrity
- Small, space saving footprint
- New high yield gripper for minimum butt ends (2 1/2 to 3 1/2oz typical)
- Hygienic, stainless steel construction to 'ready to eat' product standards
- Safe operation backed up by CE marking
- Designed to be simple to operate, service and maintain
- **new Predictive Upgrade for retail packs**
 - Enhanced on-weight performance for stacked and shingled retail drafts reduces rework
 - Reduction of EOL giveaway by up to 3.5%
 - Includes a predictive weighcell positioned adjacent to the slicer on a mobile stand. For best performance a process weigher is recommended

Predictive Technology - How it works

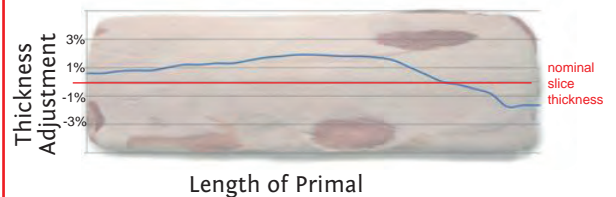

- Average changes through the length of the primal, i.e. fat/lean ratio, density and size, are used to create a predicted "Profile", which is used to automatically adjust the slice thickness as the slicer proceeds along the product length.
- To account for variation in the actual size of the primal a pre-slicer weighcell is used to "scale" the profile according to weight.
- A predictive slicer's performance is enhanced with pressed product as this reduces variance and makes the product more predictable.

Pack presentations include:



Bulk

Bulk with pack definition





shingle

stand up

lay flat slices

Technical Information	
Feed	Gripper feed with load assist table
Blade	Involute
Max. speed	up to 1500 rpm
Slice thickness	0.5 to 30 mm
Max. cutting area (WxH)	11 3/4" x 4" approx.
Max. product length	33 1/2"

Services	
Electrical	380V to 460V ± 10%, 50/60Hz @ 11kVA, 3 Phase + Earth & Neutral
Air	10 Normalized liters/min @ 5 bar min.
Weight	2200 lbs

Capacity Estimate, 1500rpm				
				
Bulk, 4 mm	Bulk with Pack Definition, 16 slices, 4mm	Layout, 10 slices, 4mm	Retail Shingles, 8 slices, 4mm, 8oz	Stand up pack, 16 slices, 4mm, 16oz
2623 lbs/hr 5 bellies / min	2548 lbs/hr 42 packs/min	1406 lbs/hr 42 sheets/min	2227 lbs/hr 40 packs/min	2410 lbs/hr 40 packs/min

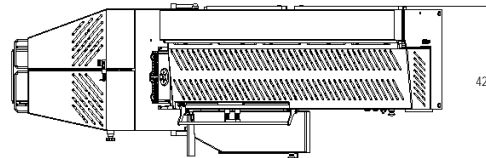
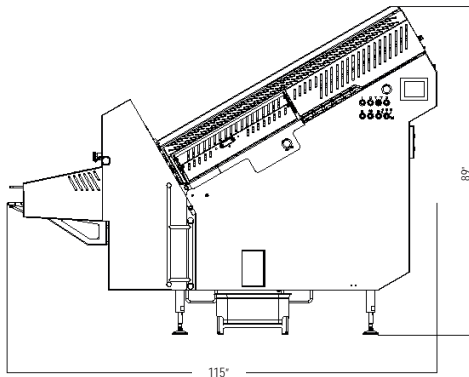

CONTACT

Thurne USA
 4300 West Bryn Mawr Avenue • Chicago, IL 60646-5943 • U.S.A.
 Tel: +1 773 478-9700 Fax: +1 773 478-8689

info@thurne.com
 www.thurne.com

Thurne-Middleby Ltd
 Gresham House • Pinetrees Business Park • Salhouse Road • Norwich NR7 9BB • UK
 Tel. +44 (0)1603 700755 • Fax. +44 (0)1603 700844